

PITTING

Scattered (pin) holes dispersed over the majority of the surface.



HINTS

- Shorten the polishing time (use enough but short steps)
- Use lower pressure
- Use harder carriers/tools – combination diamond paste and lubricants is important
- Avoid unidirectional movements during preparation of the surfaces
- Dry the workpiece and store properly to avoid corrosion attacks on the surface
- If the pitting defects only appears in a local area on the surfaces it probably due to impurities in the material

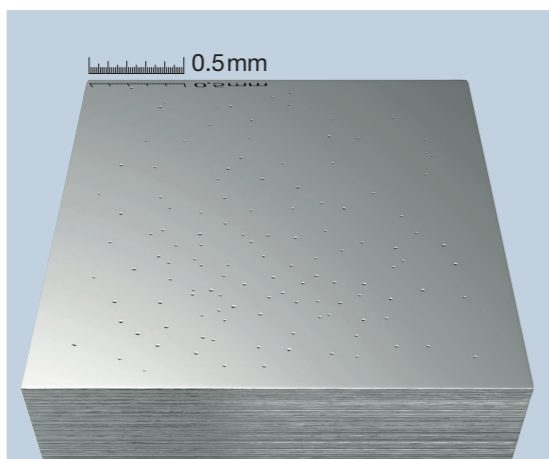

3D MEASUREMENT AND PROFILE

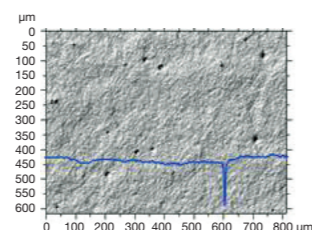

COMET TAILS

Scattered holes with a tail, dispersed over the majority of the surface.



HINTS

- Avoid unidirectional movements
- Use higher rotational speed if manual polishing

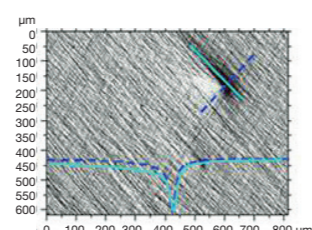
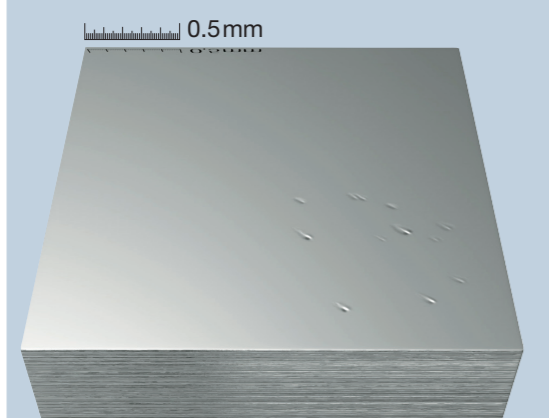

HOLE

Smaller irregular or circular shaped cavity, e.g. pores, pinholes and imprints by abrasives.



HINTS

- Choose a cleaner steel i.e. ESR steel grade
- Use softer carriers/tools (without lint)
- Use lower pressure
- Napless polishing cloths reduce the risk for pull-outs
- Use a fluoride-free polishing cloth

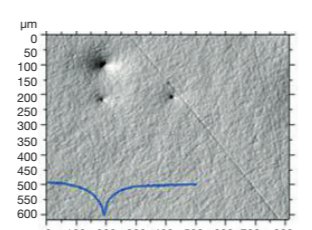
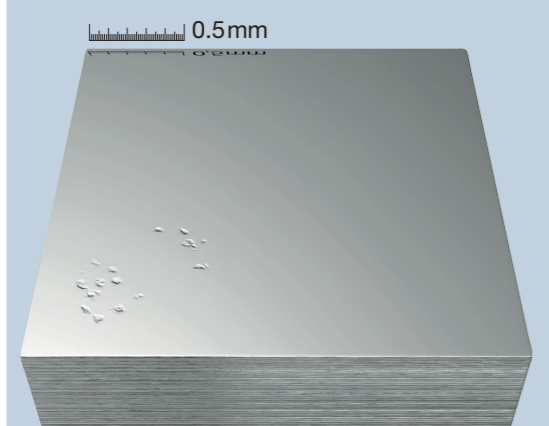

GROOVE (scratches)

Longitudinal recession with rounded/flat bottom.



HINTS

- Clean the workpiece, tools etc. between every polishing step; remaining abrasives can scratch the surface by accident
- Be sure that marks left from previous preparation steps (e.g. turning or grinding marks) are removed
- Check if the hardness is too low

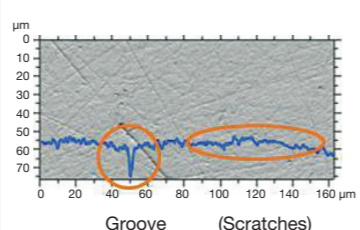
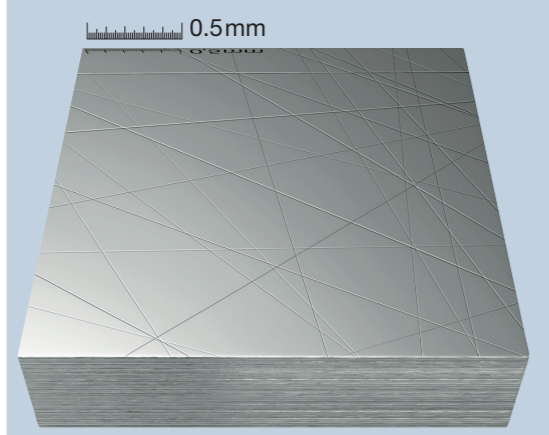

RELIEF

Hill-like formations in all kind of geometries covering the majority of the surface.



HINTS

- Choose a cleaner steel i.e. ESR steel grade
- Use harder carriers/tools
- Choose a more homogeneous steel material. Softer areas tend to be more polished than harder ones (pre-stage to orange peel)
- Decrease the polishing time (use enough but short steps)
- Polishing cloths with low pressure reduce the risk
- Use lower pressure

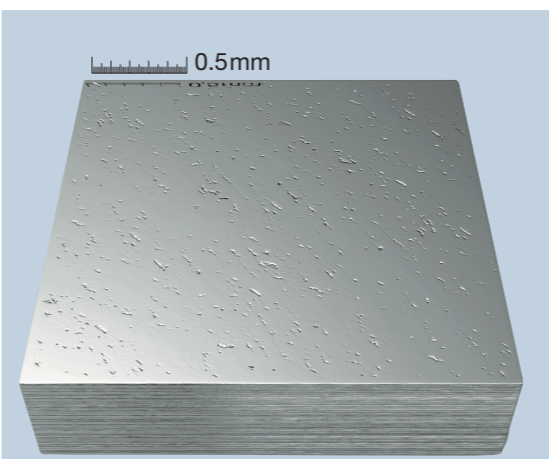

3D MEASUREMENT AND PROFILE

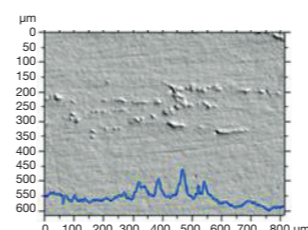

PEAK/RAISING

Small outwardly directed feature, often irregularly shaped, e.g. bare laid inclusions.



HINTS

- Choose a cleaner steel material
- Clean the workpiece to avoid surface contamination
- Use lower pressure, larger abrasive sizes, polishing cloths with higher resilience and/or a lubricant with higher viscosity to avoid embedded abrasives

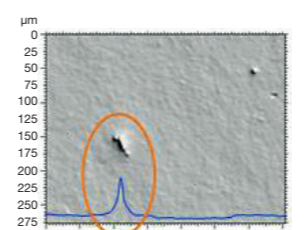
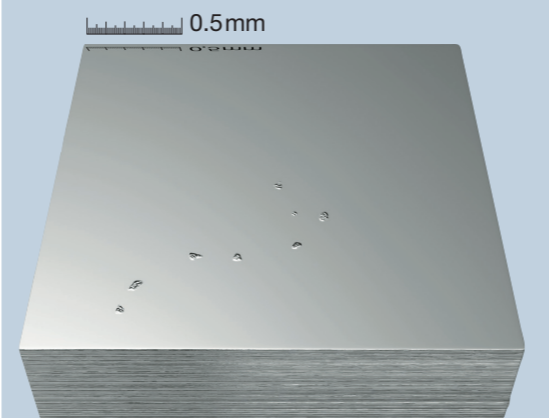

ORANGE PEEL

Randomly, smooth valleys and hills covering the majority of the surface.



HINTS

- Shorten the polishing time (use enough but short steps)
- Use harder carriers/tools
- Use lower pressure
- Increase the lubrication in order to cool down the surface

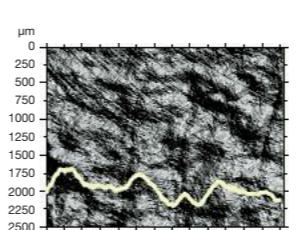
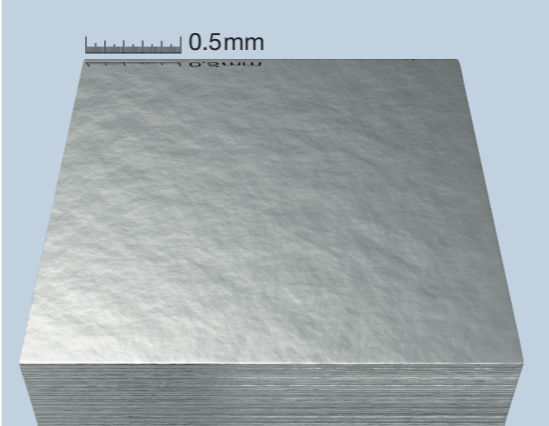

WAVINESS

Longitudinal, smooth valleys and hills covering the majority of the surface.



HINTS

- Work with tools that have a good contact to the surface
- If waviness occurs go back to the first polishing step and change to a larger tool that fits better to the geometry of the surface to be polished

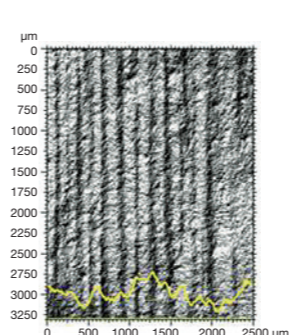
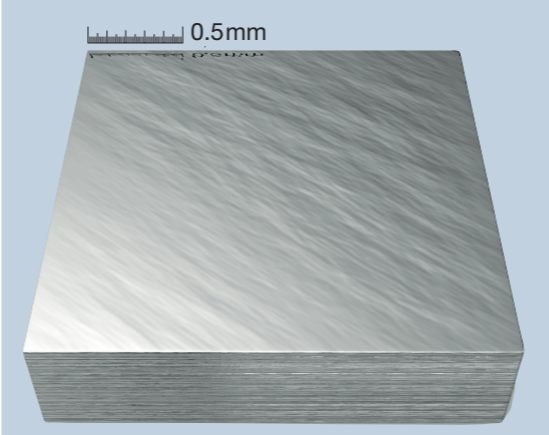

DISCOLORATION/STAINING

Discoloured areas; e.g. "milky spots".



HINTS

- Inhomogeneous microstructure is adverse
- Clean and dry the workpiece immediately after each preparation step, avoid hot water
- Compressed air can contain oil or water, which might affect the surface
- Cover the surface after polishing and store properly
- Avoid overheating during previous preparation steps which get visible during the polishing process

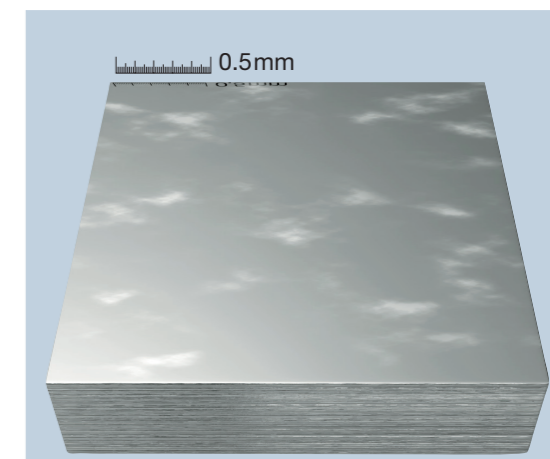

3D MEASUREMENT AND PROFILE

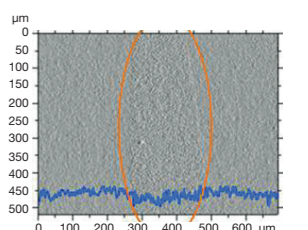

HAZE

Areas with lower gloss than the surrounding ("silvery frosted appearance").



HINTS

- Choose steel with homogenous material properties (e.g. without grain clusters in different directions and/or hardness variations)
- Might be correlated to previous processing (e.g. milling or welding operations)
- Last polishing step discarded/cancelled
- Unclean surface (insufficient carrier, wrong lubrication and diamond paste)

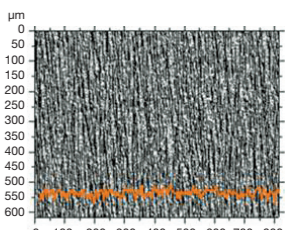
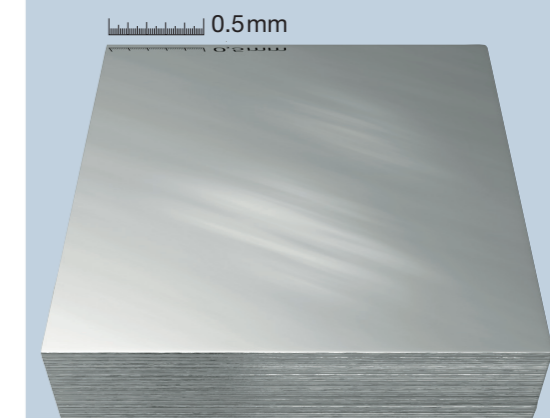

BURN MARK

Physical destruction due too high surface temp. during surface preparation. On the sample surface three different defects are shown e.g. dark bluish areas from high pressure during polishing, point shaped burns caused by EDM process and linear and laminar burns caused by grinding, welding or other operations.



HINTS

- Use lubrication in order to cool down the workpiece during surface preparation
- Use lower pressure and/or speed during surface preparation

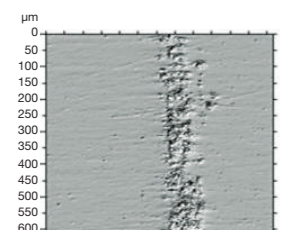
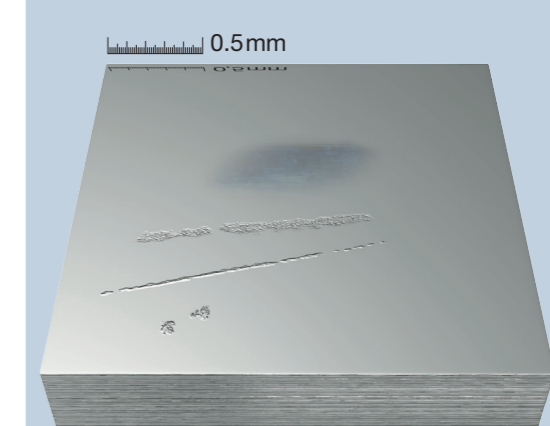

CRACK

Linear recession with a sharp bottom.



HINTS

- Crack result from surface tensions build up during the manufacturing process, i.e. change the preparation and/or the manufacturing process

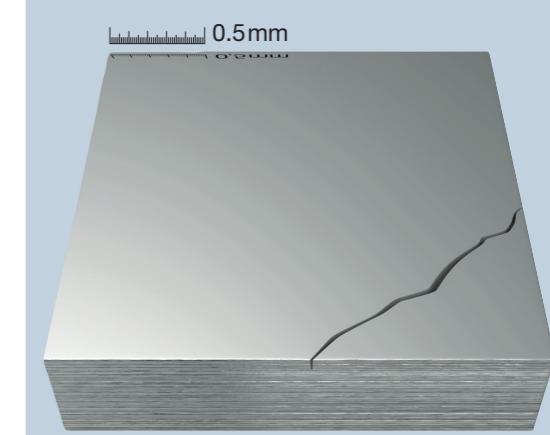

INTRODUCTION

This chart aims to give an overview of common defect structures, their size/shape and some "hints" to reduce/avoid them.

NAME AND DESCRIPTION

PITTING

Scattered (pin) holes dispersed over the majority of the surface.

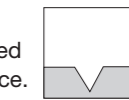

AVOIDING STRATEGIES

HINTS

- Shorten the polishing time (use enough but short steps)
- Use lower pressure
- Use harder carriers/tools – combination diamond paste and lubricants is important
- Avoid unidirectional movements during preparation of the surfaces
- Dry the workpiece and store properly to avoid corrosion attacks on the surface
- If the pitting defects only appears in a local area on the surfaces it probably due to impurities in the material

TYPE OF DEFECT

PICTURE OF THE DEFECT

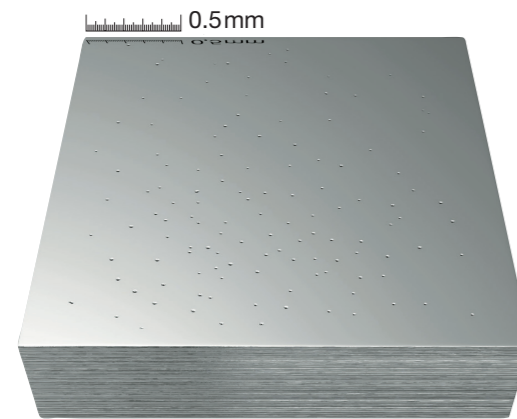

3D MEASUREMENT AND PROFILE

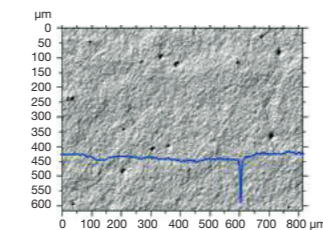

DEFECT CLASSIFICATION

Inwardly directed imperfection

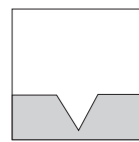

- Pitting
- Comet tails
- Hole
- Scratches/groove
- Crack

Outwardly directed imperfection

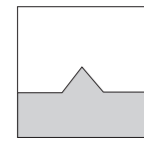

- Relief
- Peak

Areas that appear different compared to the surrounding

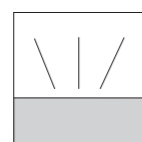

- Discoloration
- Haze
- Burn mark

Wavy surface structure

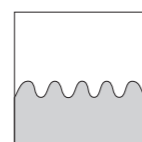

- Orange peel
- Waviness

Uddeholm is the world's leading supplier of tooling materials. This is a position we have reached by improving our customers' everyday business. Long tradition combined with research and product development equips Uddeholm to solve any tooling problem that may arise. It is a challenging process, but the goal is clear – to be your number one partner and tool steel provider.

Our presence on every continent guarantees you the same high quality wherever you are. We secure our position as the world's leading supplier of tooling materials. We act worldwide. For us it is all a matter of trust – in long-term partnerships as well as in developing new products.

For more information, please visit www.uddeholm.com

DEFECT CHART AND HINTS FOR HIGH GLOSS POLISHING OF STEEL SURFACES



UDDEHOLM 10.2017.200 / STRÖMBERG-LANUSSTHÖNS-Karlskrona

© UDDEHOLMS AB

No part of this publication may be reproduced or transmitted for commercial purposes without permission of the copyright holder.

This brochure has been produced in co-operation with the Functional Surfaces Research Group at University of Halmstad, Sweden

