

Uddeholm  
tool steels for

# FORGING APPLICATIONS



© UDDEHOLMS AB

No part of this publication may be reproduced or transmitted for commercial purposes without permission of the copyright holder.

---

This information is based on our present state of knowledge and is intended to provide general notes on our products and their uses. It should not therefore be construed as a warranty of specific properties of the products described or a warranty for fitness for a particular purpose.

Classified according to EU Directive 1999/45/EC  
For further information see our "Material Safety Data Sheets".

Edition 4, 10.2017



Selecting a tool steel supplier is a key decision for all parties, including the tool maker, the tool user and the end user. Thanks to superior material properties, Uddeholm's customers get reliable tools and components. Our products are always state-of-the-art. Consequently, we have built a reputation as the most innovative tool steel producer in the world.

Uddeholm produce and deliver high quality Swedish tool steel to more than 100,000 customers in over 100 countries.

Wherever you are in the manufacturing chain, trust Uddeholm to be your number one partner and tool steel provider for optimal tooling and production economy.

## CONTENTS

---

Hot forging of metals	4
Warm forging	7
Progressive forging	8
Effect of forging parameters on die life	10
Die design and die life	11
Requirements for die material	14
Manufacture and maintenance of forging die	16
Surface treatment	17
Tool steel product programme	19
– General description	19
– Chemical composition	20
– Quality comparison	20
Tool steel selection chart	21

*Cover illustration:* Connecting rod forging tool.

Most of the photos are coming from Arvika Smide AB, Sweden and Fiskars Brands Finland Oy Ab

## HOT FORGING OF METALS

In hot forging a heated up billet is pressed between a die set to a nearly finished product. Large numbers of solid metal parts are produced in aluminium alloys, copper alloys, steel or super-alloys where irregular shapes need to be combined with good mechanical properties. The main methods of drop forging are hammer forging and press forging.

### HAMMER FORGING

Hammer forging is characterized by a very short contact time and very rapid rate of increase of force with time (impact loading). The cumulative contact time for the bottom die can be fairly long if one includes the time between blows. However, since a lubricant with “blow-out” effect is normally used with hammers, effective contact between the part and the die only occurs during the actual forging blow.

These features imply that impact toughness and ductility are important properties for die steel to be used in hammer dies. This does not mean to say that wear resistance is not important, particularly in smaller dies, which in fact normally fail as a result of wear.

In hammer forging, there is a lot to be said for using inserts of a more wear-resistant die steel which are shrink fitted into a tough holder material.

For larger, high-production hammer dies, which may be resunk a number of times, it is important that the die steel used has sufficient hardenability that the later cavities are not sunk in softer material with inferior wear resistance.

### PRESS FORGING

In press forging, the contact time under pressure is much longer, and the impact load is much lower than in hammer forging. In general terms, this means that the heat resistance and elevated temperature wear resistance of the die steel are relatively more important than the ability to withstand impact loading. However, one must optimize impact toughness and ductility in relation to wear resistance; this applies particularly for large press dies which are not supported from the sides. Since the surface temperature of press dies will during service generally be higher than for hammer dies, it is important that the die surface is not excessively chilled by lubrication. Otherwise, premature heat checking or even thermal shock cracking may result.



## TYPICAL DIE FAILURES

The deterioration of forging dies is usually associated with several processes which may operate simultaneously. However, one of these normally dominates and is the ultimate cause of failure. In general, four distinct damage mechanisms can be distinguished:

- wear
- mechanical fatigue and gross cracking
- plastic deformation
- thermal fatigue cracking (heat checking)

Different damage mechanisms can dominate in different parts of the cavity.

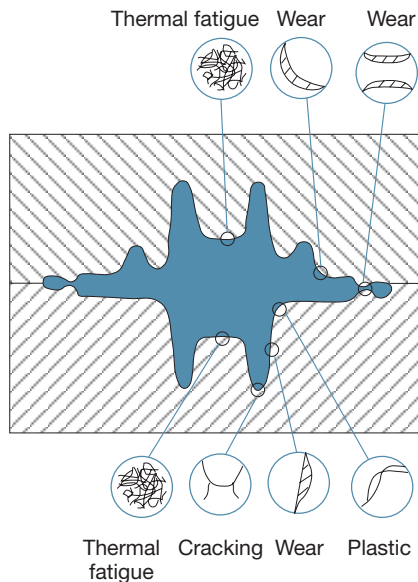

## WEAR

If all other damage mechanisms are suppressed, a forging die will ultimately wear out (parts out of tolerance). Wear occurs when the work material plus oxide scale glide at high velocity relative to the cavity surface under the action of high pressure. It is most pronounced at convex radii and in the flash land. Wear is increased drastically if the forging temperature is reduced (higher flow stress for the work material).

The explosion which occurs via combustion of oil-based lubricant in the confined space between forging and die can also give rise to a type of erosive wear.

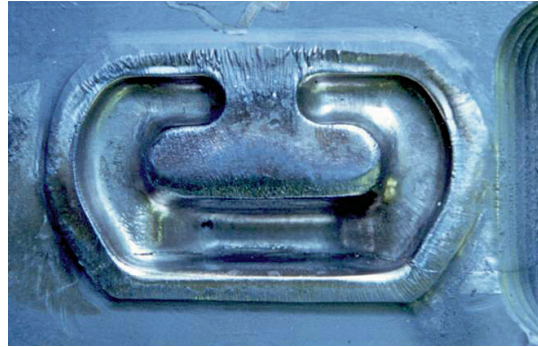

*Wear.*

## GROSS CRACKING

Forging dies might fail as a result of some form of gross cracking. This may occur during a single cycle or, as is most common, over a number of cycles; in the latter instance, the crack growth proceeds via a high-stress fatigue mechanism. Gross cracking is more frequent in hammer blocks than in press tooling, because of the greater degree of impact.



Gross cracking is a failure condition which can almost always be rectified. Normally, cracking lies in one or more of the following:

- overloading, e.g. work material temperature too low
- die design, e.g. too sharp radii or too thin wall thickness
- inadequate preheating of the die
- inadequate toughness of die steel (wrong selection)
- too high hardness of die material
- poor quality heat treatment/surface treatment
- inadequate die support/alignment treatment

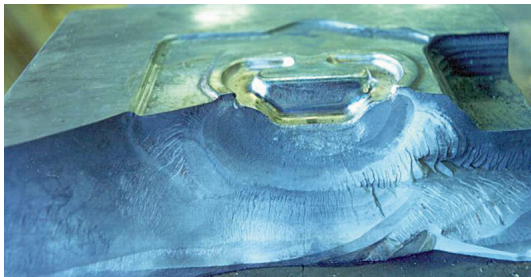

*Totally cracked die.*

#### PLASTIC DEFORMATION

This occurs when the die is locally subjected to stresses in excess of the yield strength of the die steel. Plastic deformation is quite common at small convex radii, or when long thin tooling components e.g. punches, are subjected to high bending stresses.

The following can be the cause of plastic deformation in forging dies:

- too low billet temperature (high flow stress of work material)
- inadequate hot strength of die steel
- die temperature too high
- die material too soft

#### THERMAL FATIGUE CRACKING

This results if the surface of the cavities is subjected to excessive temperature changes during the forging cycle. Such temperature changes create thermal stresses and strains at the die surface which eventually lead to cracking via a low-cycle fatigue mechanism (heat checking).

Thermal fatigue cracking is increased by the following factors:

- cavity surface at too high temperature (excessive billet temperature and/or long contact time)
- excessive cooling of die surface between forgings
- inadequate preheating of die
- wrong selection of die steel and/or poor heat treatment

All these factors will increase the difference between maximum and minimum temperature in the die surface.



## DIE MATERIAL PROPERTIES

The properties profile required for tool steel in forging dies depends to some extent on the type of forging operation, on the work material and on the size of the part, depth of cavity etc. However, a number of general characteristics will always be required in all forging operations. The particular die damage mechanisms are given in parentheses.

- Sufficient hardness and ability to retain this at elevated temperatures – temper resistance (wear, plastic deformation, thermal fatigue cracking).
- Enhanced level of hot tensile strength and hot hardness (wear, plastic deformation, thermal fatigue cracking).
- Good toughness and ductility at low and elevated temperatures (gross cracking, thermal shock cracking, thermal fatigue cracking). It is important that the die steel exhibits adequate toughness/ductility in all directions.
- Adequate level of fatigue resistance (gross cracking).
- Sufficient hardenability (retention of wear resistance etc. if the die is resunk).
- Amenability to weld repair.
- Good machinability, especially prehardened die blocks.

## WARM FORGING

Warm forging is a precision forging operation carried out at a temperature range between 550–950°C (1020–1740°F). It is useful for forging of details with intricate shapes, with desirable grain flow, good surface finish and tighter dimensional tolerances than if hot forged.

The weight of the forged piece is between 0.1–50 kg (0.22–110 lbs) and the production rate about 10–40 pieces per minute. The contact time is about 200 ms and the mechanical loads at 600°C (1110°F) are 3 to 5 times higher than in hot forging. Automatic multistation presses with integrated cooling/lubricating systems are often used.

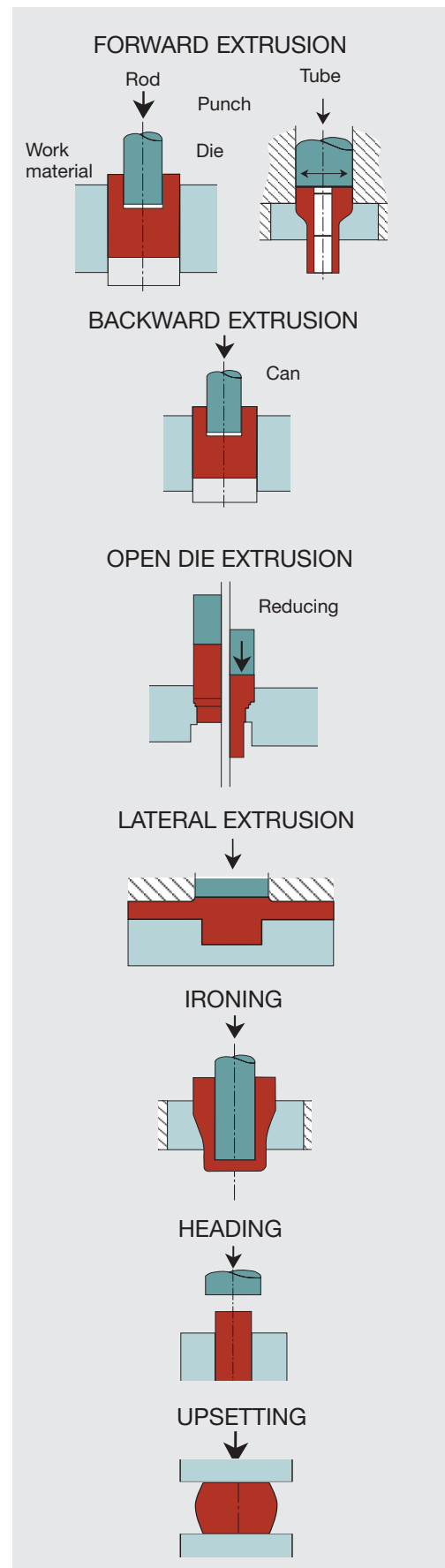

Typical processes in warm forging.

## TYPICAL FAILURES

During the warm forging operation the tool parts are exposed to rather high temperature, high mechanical loads and intensive cooling.

As a result of this alternate heating and cooling the tool parts are subjected to high thermal fatigue.

An additional factor is the degree of hot wear of the material, which depends on the surface temperatures and the mechanical stresses on the tool.

## TOOL MATERIAL PROPERTIES

The tool parts are subjected to both high mechanical stresses and high thermal stresses. For these reasons a tool steel has to be chosen which has a good temper resistance, good wear resistance, high hot yield strength, good thermal conductivity and good thermal fatigue resistance. A warm forging steel must exhibit a properties profile which is in between the typical properties profiles for hot work and cold work steel.

## PROGRESSIVE FORGING

In progressive forging a large number of symmetrical, precision-forged parts with forged weights of up to about 5 kg (11 lbs) are produced. The fully automatic process involves supplying hot rolled bars at one end of the line, heating them inductively, cutting them to the required size, shaping them in 3–4 stages and discharging finished forgings at the other end of the line.

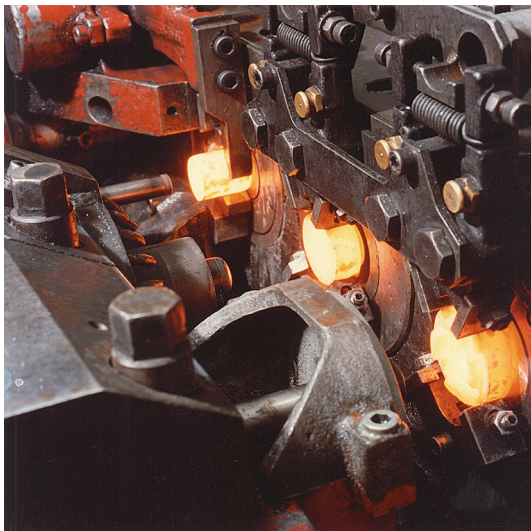

Depending on the weight of the forgings, production capacity is between 50 and 180 per minute.

## TYPICAL FAILURES

Tool parts used in the progressive forging, such as die, stem, stem holder, punch and counter punch-ejector are subjected to very high stresses.

As the production speed is very high, the die parts need to be water-cooled to protect them against overheating. Nevertheless, despite intensive cooling, the tool surfaces can be strongly heated, even by the brief contact, with the hot metal being forged.

As a result of this alternate heating and cooling the die parts are subjected to extremely high thermal fatigue. The degree of the thermal fatigue cracking constitutes a measure of the material life.

An additional factor is the degree of hot wear of the material, which depends on the surface temperatures and the mechanical stresses on the die.

## TOOL MATERIAL PROPERTIES

The required properties profile of the hot forming die and die parts are:

- high temperature strength and good temper resistance to withstand hot wear and thermal fatigue cracking
- good thermal conductivity to withstand thermal fatigue cracking
- good hot ductility and toughness to resist initiation and rapid spread of thermal fatigue cracking



### FORGING IN A FULLY AUTOMATIC PROCESS

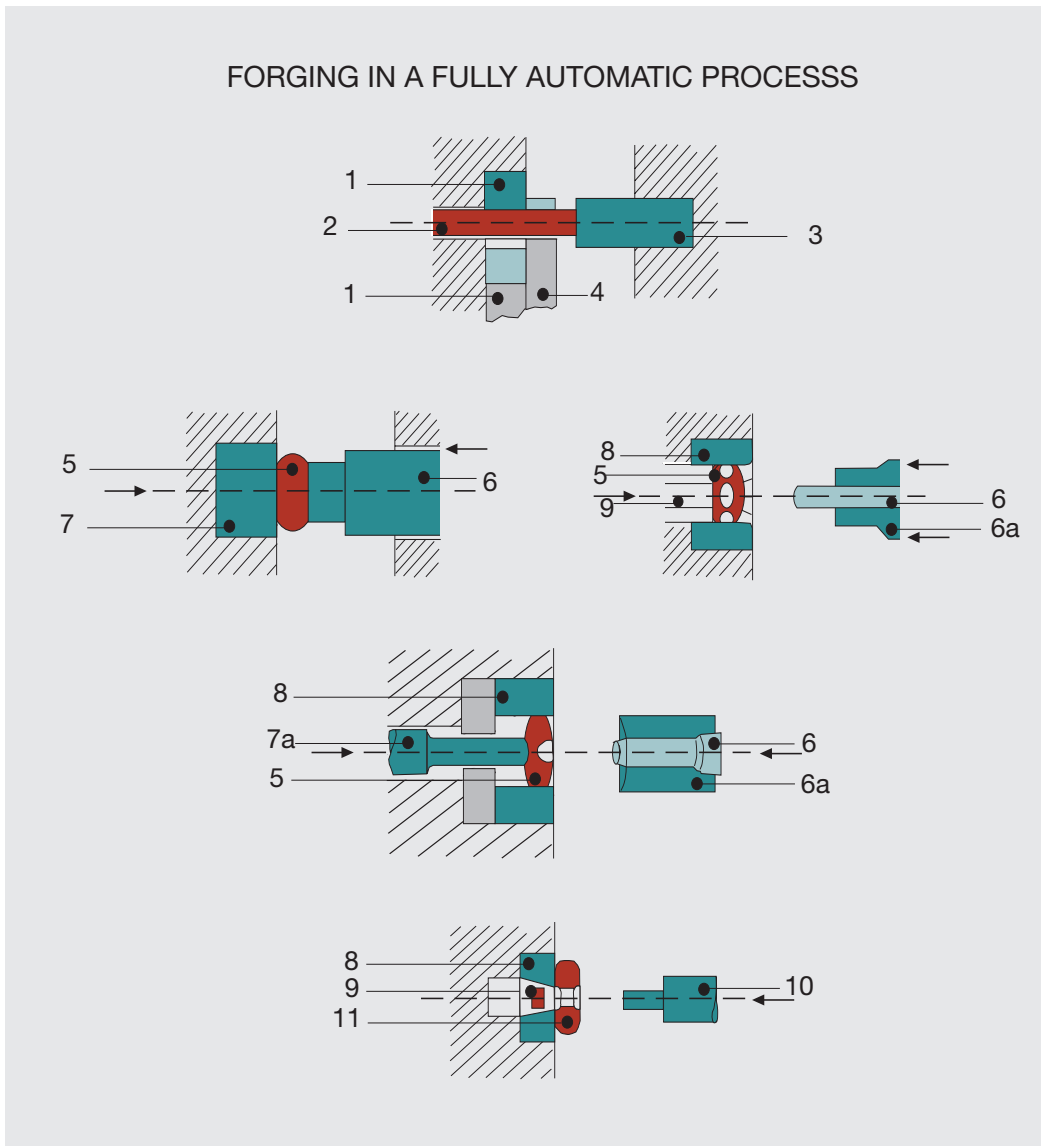

- 1 Two-part cutting bush
- 2 Work metal
- 3 Stopper
- 4 Cutter
- 5 Blank
- 6 Stem/Punch
- 6a Hollow punch
- 7 Bolster
- 7a Counter punch-ejector
- 8 Die
- 9 Waste metal
- 10 Piercer
- 11 Product

## EFFECT OF FORGING PARAMETERS ON DIE LIFE

Apart from the influence of the actual die material and its heat treatment/surface treatment, a number of parameters related to the forging operation affect die life:

- billet temperature
- billet shape and surface condition
- work material
- cavity stress level and contact time
- type of forging operation
- type of lubricant

### BILLET TEMPERATURE

Reduced billet temperature in forging is favourable from the viewpoint of mechanical properties in the forged part itself. This is particularly important if the components are not heat treated after forging. However, the higher flow stress of the work material, which is associated with a reduced forging temperature, results in both increased wear and a higher risk for plastic deformation. Further, since the forging loads increase, the probability for gross cracking is enhanced.

### TYPICAL HOT FORGING TEMPERATURES

STEEL	1050–1250°C (1920–2100°F)
CU-ALLOYS	650–800°C (1200–1470°F)
AL-ALLOYS	350–500°C (660–930°F)
TI-ALLOYS	800–1000°C (1470–2010°F)

### BILLET SHAPE AND SURFACE CONDITION

The greater the difference between the shape of the billet and that of the final forging, the greater is the degree of wear because the relative movement between work material and die must increase. Likewise, hard, adherent scale on the billet surface will increase wear, especially if the gliding distance is large.

### WORK MATERIAL

The higher the flow stress of the work material, the faster is die deterioration due to wear and/or plastic deformation, at the same time as the risk for gross cracking is increased. Hence, stainless steel is more difficult to forge than carbon steel at the same temperature.

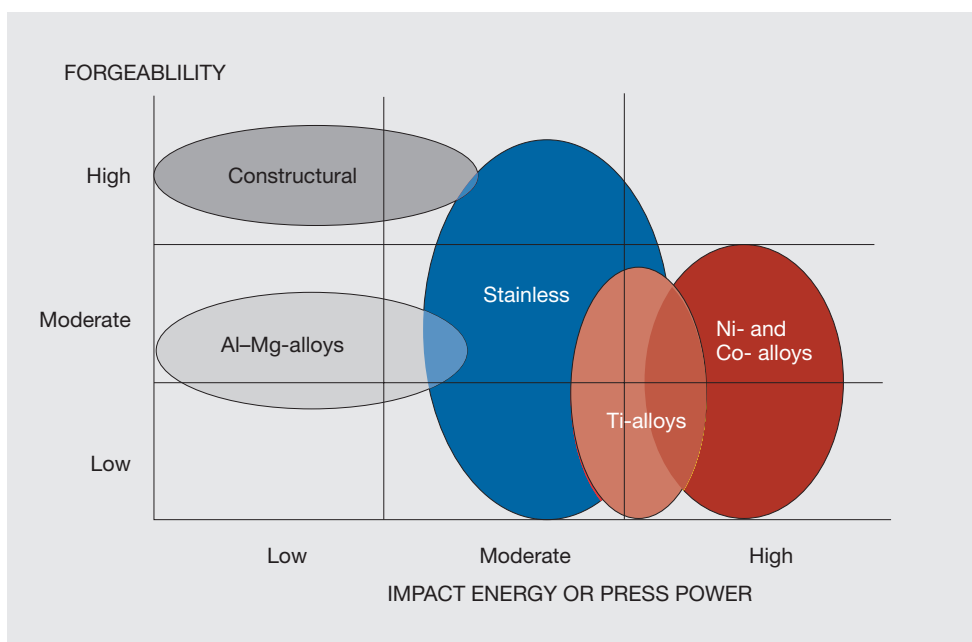

Forgeability of different types of material.

## CAVITY STRESS LEVEL AND CONTACT TIME

An increased stress level in the cavity, can be found, for example, in high precision forging, and has the following consequences:

- increased stress in the tool with higher risk for deformation or gross cracking
- increased heat transfer from billet to die (heat checking)
- more pronounced wear

Prolonged contact between billet and die during forging results in accelerated wear and a greater risk for heat checking. For very long contact times, the surface layer of the tool may become so hot that it transforms to austenite. Cracking problems can then be experienced if this layer rehardens during the cooling part of the cycle.

## TYPE OF FORGING OPERATION

Because of the much higher impact load, hammer dies tend to fail by cracking to an extent which is greater than in press forging where the loading rate is lower. Thermal fatigue (heat checking) is more common in powder forging and other near-net-shape forging processes involving long contact times.

## TYPE OF LUBRICANT

Oil-based lubricants can give rise to excessive wear/erosion due to the explosion-like combustion of the oil between billet and cavity. On the other hand, water base lubricants cool the die surface to a greater extent which increases the risk of thermal fatigue cracking.



## DIE DESIGN AND DIE LIFE

Assuming that the forging equipment is in good condition (properly adjusted and without excessive play in the ram guide system), then adherence to the following “die design” principles will reduce the risk for catastrophic die failure:

- proper die support
- dovetails, if used, should be properly dimensioned, have sufficiently large radii and be properly finished (grinding marks should be tangential and not axial), see figure below.
- sufficient wall thickness, and sufficient material below the cavity and between individual cavities
- adequate radii and fillets in the cavity
- proper dimensioning of flash land and gutter
- proper design of parting plane and, if used, die locks
- correct use and design of setting plugs, punches and knockout pins
- sufficiently large cushion-face area in hammer forging in relation both to die block thickness and to the capacity of the hammer used

Improper die support, insufficient material thickness in the die and too small radii are all very common reasons for a die failing catastrophically by cracking, and will be further enlarged upon.

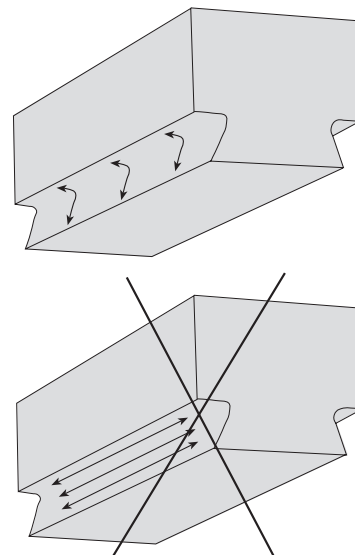

Grinding of dove-tail radii.

### DIE SUPPORT

It is very important that the die is properly supported underneath by a perfectly flat backing surface with sufficient hardness. Concave depressions in the support surface immediately under the die cavity are particularly deleterious because they exaggerate the tensile stresses at radii.

Proper backing is especially important in hammer forging because there is usually no side support in this case. When dies of greatly different dimensions are used on the same press or hammer, it is essential to remove any cavities in the backing block or plate when switching from a small to a large die.

For press forging, side support of the die is desirable but this is not always possible. Shrink fitting of inserts into a massive holder provides the best security against cracking in press dies.

### FILLET RADII

The greatest tensile stresses in a forging die occur at the radii between the sides and bottom of the cavity. The smaller the radius, the higher the stresses. In general, the forging should be designed so that die fillet radii less than 2 mm (0.08 inch) can be avoided. For deeper cavities, >50 mm (>2 inch), this radius limit needs to be increased to 5 mm (0.2 inch).

It is especially important during die making that radii are ground and polished with grinding marks, if any, in the tangential direction. In particular, EDM residues, which may contain cracks, must be removed completely at radii (and preferably from the rest of the die as well). If this is not possible, then the die should at least be retempered at 25°C (50°F) below the previous tempering temperature.

### DIE MATERIAL AND WALL THICKNESS

A number of more or less empirical methods or dimensioning of forging dies are available, which range in complexity from simple “rule of thumb” to fairly advanced nomograms with a theoretical base. However, there is no doubt that the stresses imparted to the die by a given forging machine increase profoundly as the die dimensions are decreased.

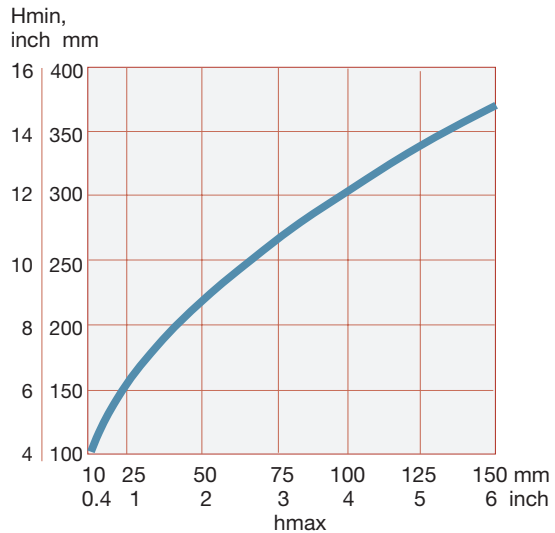

Minimum height (*Hmin*) of hammer dies with a maximum depth of cavity (*hmax*).

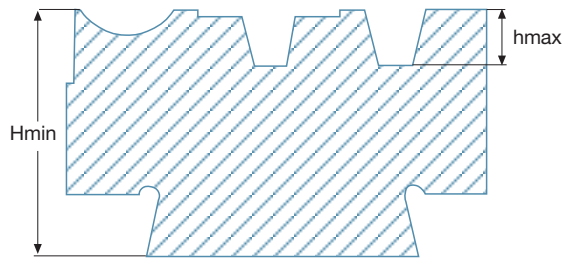

As a rule of thumb for solid die blocks in press forging the thickness below the cavity should be at least 1.5 x cavity depth.

As a minimum wall thickness in hammer forging the recommendations are according to the table below.

Depth of cavity ( <i>h</i> )		Distance cavity to outer edge of a die ( <i>t</i> )	
mm	inch	mm	inch
6	0.2	12	0.5
10	0.4	20	0.8
16	0.6	32	1.3
25	1.0	40	1.6
40	1.6	56	2.2
63	2.5	80	3.2
100	3.9	110	4.3
125	4.9	130	5.1
160	6.3	160	6.3

Minimum wall thickness (*t*) recommended in hammer dies between cavity and outer edge.

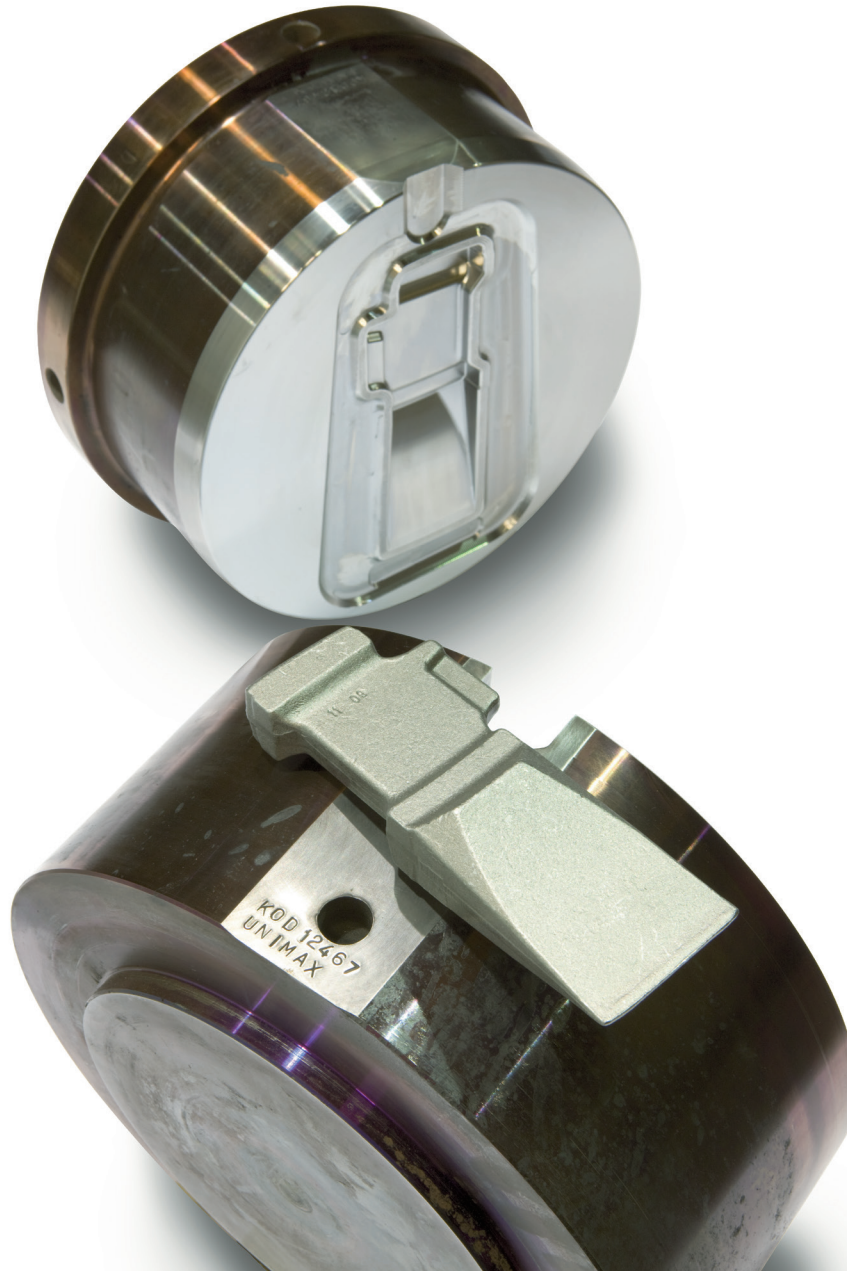

## REQUIREMENTS FOR DIE MATERIAL

### HARDENABILITY

In large press or hammer dies made from pre-hardened die steel, it is important that the hardness is uniform throughout the block. If the die steel has too low hardenability, the block will become softer away from its outer surface and die life for deep cavities or after progressive resinking will be impaired.

### TOUGHNESS AND DUCTILITY

The surface of the cavity can during use easily develop small cracks or other blemishes which may propagate in an unstable manner under the action of the high forging stresses, especially at radii etc. Notch toughness indicates the ability of the die material to resist crack development from such defects.

All products, in the Uddeholm tool steel programme for the forging industry, are characterized by the highest levels of toughness and ductility in all directions in the bar or block. Hence, the forger can rest assured that the resistance to gross cracking is the highest possible in dies made from Uddeholm die steel.

Proper die preheating will considerably reduce the risk for catastrophic failure via cracking.

### TEMPER RESISTANCE

The better the steel retains its hardness as the temperature or the time increases, the better its temper resistance.

Temper resistance can be assessed from the tempering curve for a hardened tool steel. In this, the hardness at room temperature is plotted against tempering temperature for given tempering time. Another method of



presenting temper resistance data is to plot room temperature hardness against time at a given tempering temperature.

### HOT STRENGTH AND HOT HARDNESS

In contrast to temper resistance, which is defined in terms of hardness at room temperature, hot strength and hot hardness refer to properties at high temperature. In general, improved temper resistance is associated with increased hot strength and hot hardness. It can be pointed out that good hot hardness and hot strength are important prerequisites for enhanced wear resistance at elevated temperatures.

A high level of hot hardness and hot strength is also important in order to achieve adequate resistance to thermal fatigue cracking.



### FATIGUE RESISTANCE

Uddeholm tool steel for forging dies are produced to the highest possible quality standards, especially with regard to freedom from non-metallic inclusions. This imparts a degree of fatigue resistance which is adequate for even the most demanding applications where forging dies are subjected to cyclic loading with high maximum loads.

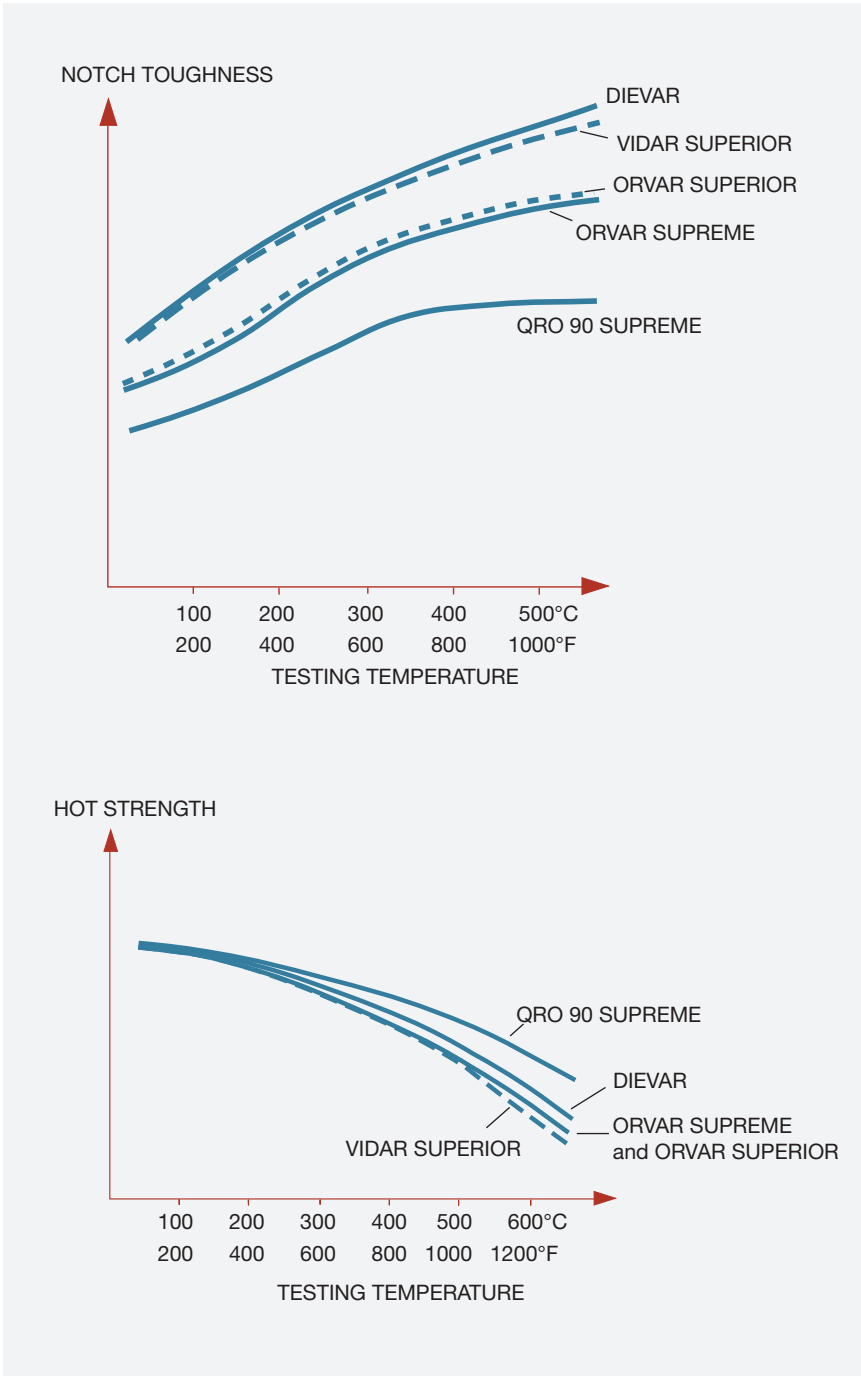

## MANUFACTURE AND MAINTENANCE OF FORGING DIE

Machinability, weldability and, when applicable, response to heat treatment and surface treatment are important parameters influencing the relative ease of manufacture and maintenance of forging dies.

### MACHINABILITY

Machinability is a vital consideration when forging dies are machined from prehardened die blocks.

The tool steel for forging applications from Uddeholm are characterized by freedom from oxidic inclusions and a uniform microstructure. These features, in combination with the low hardness in the annealed condition usually 170–200 HB, are to ensure excellent machinability.

worth consulting in the context of forging die manufacture are “Grinding of tool steel” and “Electrical Discharge Machining (EDM) of tool steel”.

### HEAT TREATMENT

If forging dies are manufactured from die steel in the annealed condition, then the tool must subsequently be heat treated in order that the steel develops its optimum combination of hardness, toughness, heat resistance and wear resistance.

These properties are controlled through proper choice of austenitizing temperature, cooling conditions during hardening and tempering temperature and time. The Uddeholm brochure “Heat treatment of tool steel” will be worth consulting.

For forging dies, where toughness is of the utmost importance, it is essential that the cooling rate during hardening is sufficiently

NOTCH TOUGHNESS

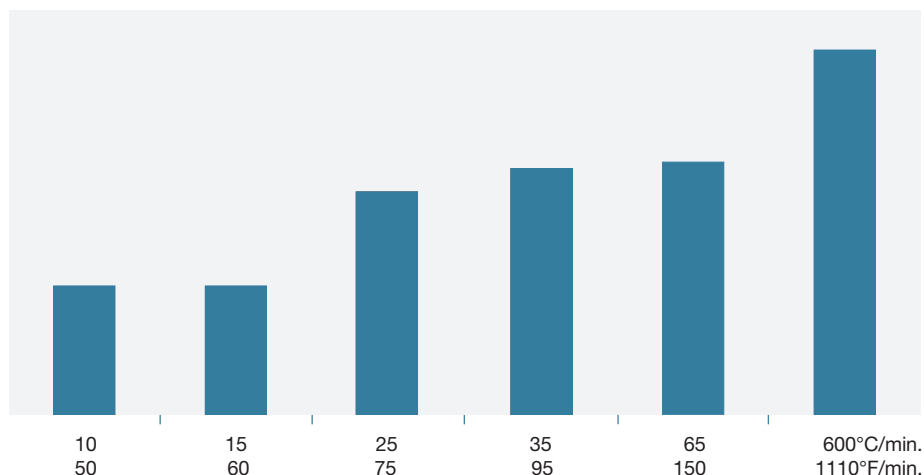

Notch toughness of Uddeholm Orvar Supreme, 44–46 HRC, as a function of quench rate.

Even if these grades are supplied pre-hardened, the extreme cleanliness and microstructural homogeneity ensure that machining can normally be carried out without difficulty.

For all products, advanced process control guarantees that the variations in machining characteristics are minimal from batch to batch.

Uddeholm’s product brochures give detailed information regarding machining of the products. Other Uddeholm publications

rapid that undesirable microconstituents such as pronounced grain-boundary carbide precipitation, pearlite and coarse upper bainite can be avoided. Furthermore, the austenitizing conditions should be such that excessive grain growth can not occur, since this is detrimental as regards to toughness. Because forging dies are sometimes EDM’d extensively after heat treatment, there is generally no problem to cope with the greater dimensional change and distortion which results when the rate of cooling during hardening is rapid. Remember, however,



that EDM'd dies should always be given an additional temper at about 25°C (50°F) below the previous tempering temperature. Detailed heat treatment recommendations for the various grades, in Uddeholm's tool steel programme for forging dies, are given in the product brochure for each individual product.

## WELD REPAIR OF FORGING DIES

Cracked or worn forging dies are often refurbished via welding. This is especially true in the case of large dies where the tool steel itself represents a considerable portion of the total die cost.

Further information can be obtained from the Uddeholm publication "Welding of tool steel".

## SURFACE TREATMENT

The cavity in forging dies is quite often surface treated in order to enhance wear resistance.

### NITRIDING

Nitriding is a thermochemical treatment giving a hard surface layer which is very resistant to wear. In favourable cases, the process also renders a compressive residual stress in the surface of the die which helps counteract heat checking. However, the nitrided layer is very brittle and may crack or

spall when subjected to mechanical loading, especially impact loading. Nitriding is usually carried out by one of four methods, nitrocarburizing in salt-bath or gas, gas nitriding or plasma (ion) nitriding.

Before nitriding, the tool should be hardened and double tempered, the latter at a temperature at least 25–50°C (50–90°F) above the nitriding temperature.

The surface hardness attained and the thickness of the nitrided layer depend on the nitriding method, nitriding time and the character of the steel being treated. Typical data can be found in the Uddeholm product brochures for the different tool steel.

Nitriding to layer thicknesses >0.3 mm (>0.012 inch) is not to be recommended for forging dies. The reason is that the nitrided layer is brittle and easily cracks during service. The underlying steel can not resist the propagation of such surface cracks if the layer thickness is too great and the entire die may fail catastrophically. 0.3 mm (0.012 inch) maximum nitride layer thickness is a general recommendation; this maximum value should be decreased if the impression has very sharp radii or if the die steel is used at high hardness.

The formation of the so-called "white layer" should also be avoided because of brittleness.

### BENDING STRENGTH

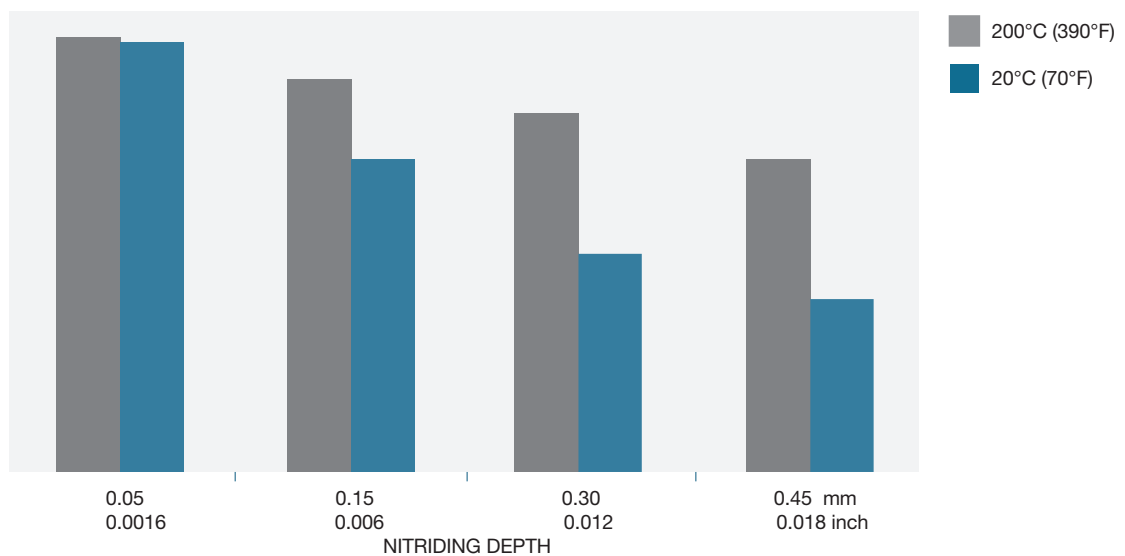

*Bending strength of Uddeholm Orvar Supreme as a function of nitriding depth.*



# TOOL STEEL PRODUCT PROGRAMME FOR FORGING APPLICATIONS





































## GENERAL DESCRIPTION

UDDEHOLM TOOL STEEL	
Dievar	Uddeholm Dievar excels in almost all areas as a hot work tool steel. The un-paralleled toughness and ductility decrease the risk of cracks in the die. Together with the high thermal conductivity and good hot strength, this makes Dievar the ideal choice for your workhorse dies. It meets the requirements of NADCA #207-2011.
Unimax	When excessive wear is experienced in the die, Uddeholm Unimax shows its true qualities. At a recommended hardness of 56–58 HRC Unimax resists abrasive wear, both hot and cold, and significantly increases the life of the forging die.
Orvar 2 Microdized	Uddeholm Orvar 2 Microdized is part of the Uddeholm basic range for forging applications. It is well-rounded steel with proven qualities and balanced properties. Orvar 2 M has stood the test of time as a reliable forging tool steel.
Orvar Supreme / Orvar Superior	Uddeholm Orvar Supreme is well-rounded steel that has proven itself as a great hot work tool steel for years. The combination of properties makes this a solid choice for your tooling needs. It meets the requirements of NADCA #207-2011.
Vidar Superior	When cracking resistance is critical, Uddeholm Vidar Superior is a great choice for forging dies. It meets the requirements of NADCA #207-2011.
QRO 90 Supreme	Uddeholm QRO 90 Supreme is perfect when the surface of the tool is subjected to excessive heat. The highest thermal conductivity in the Uddeholm hot forging steel range combined with the highest resistance to wear at elevated temperature make this advanced high strength steel a great choice for long-lasting dies.
Formvar	Uddeholm Formvar is a solid upgrade choice from H11/H13 forging dies. With good tempering back resistance and hot yield strength.
Alvar 14	Uddeholm Alvar 14 is a pre-hardened grade suitable for hammer forging. The good toughness and ease of machining make this a good choice for basic hammer forging needs.
Vanadis 23 SuperClean Vanadis 30 SuperClean	PM-produced high speed steel. Recommended for forging applications where very good wear resistance is needed.

CHEMICAL COMPOSITION

UDDEHOLM TOOL STEEL	AISI (W.-Nr.)	ANALYSIS %							Others	SUPPLIED HARDNESS Brinell
		C	Si	Mn	Cr	Mo	V			
Dievar	–	0.35	0.2	0.5	5.0	2.3	0.6	–	~160	
Unimax	–	0.50	0.2	0.5	5.0	2.3	0.5	–	~185	
Orvar 2 Microdized	H13 (1.2344)	0.39	1.0	0.4	5.3	1.3	0.9	–	~180	
Orvar Supreme	H13 (1.2344)	0.39	1.0	0.4	5.2	1.4	0.9	–	~180	
Orvar Superior	H13 (1.2344)	0.39	1.0	0.4	5.2	1.4	0.9	–	~180	
Vidar Superior	H11 modified (1.2340)	0.36	0.3	0.3	5.0	1.3	0.5	–	~180	
QRO 90 Supreme	–	0.38	0.3	0.8	2.6	2.3	0.9	Micro-alloyed	~180	
Formvar	–	0.35	0.2	0.5	5.0	2.3	0.6	–	<229	
Alvar 14	(1.2714)	0.55	0.3	0.7	1.1	0.5	0.1	Ni 1.7	≤250 or prehardened	

QUALITATIVE COMPARISON OF RESISTANCE OF BASIC PROPERTIES

UDDEHOLM TOOL STEEL	HOT WEAR	PLASTIC DEFORMATION	PREMATURE CRACKING	HEAT CHECKING
Dievar				
Unimax				
Orvar 2 Microdized				
Orvar Supreme				
Orvar Superior				
Vidar Superior				
QRO 90 Supreme				
Formvar				
Alvar 14				

The longer the bar, the better.

## TOOL STEEL SELECTION CHART

### GENERAL DESCRIPTION

FORGING APPLICATION		UDDEHOLM STEEL GRADE	HARDNESS RANGE	CAVITY DEPTH
HAMMER FORGING	Solid die blocks	Alvar 14 – Pre-hardened	400–440 HB 360–400 HB 320–360 HB ≤320	max 20 mm (0.8 inch) max 50 mm (2 inch) max 150 mm (6 inch) very deep
	Inserts	Vidar Superior  Orvar Superior	Dievar Orvar Supreme 38–50 HRC	
PRESS FORGING	Dies	Dievar Vidar Superior Orvar Supreme Orvar Superior QRO 90 Supreme Unimax Formvar	38–57 HRC	
WARM FORGING	Tools	Unimax Dievar Formvar *	50–58 HRC	
PROGRESSIVE FORGING	Tools	QRO 90 Supreme Unimax Dievar Formvar *	48–54 HRC	
UPSET FORGING	Tools	Unimax Dievar Formvar	46–56 HRC	

\* Uddeholm PM grades can be used in some tool parts. Higher hardnesses can be used.





Manufacturing solutions for generations to come

# SHAPING THE WORLD®

We are shaping the world together with the global manufacturing industry. Uddeholm manufactures steel that shapes products used in our every day life. We do it sustainably, fair to people and the environment. Enabling us to continue shaping the world – today and for generations to come.